

34'-1.20" (409.20) OVERALL LENGTH

244.50

233.00

48

48

52

27

40

64

LADDER STORAGE
40" DEEP

39

STOKES BASKET
BACKBOARD
BACKBOARD
90" DEEP
600 LBS

24" DEEP

92.86

113.97*

8*

140.75 BODY CA



145.75 TRUCK CA

199.75 WHEEL BASE

ROADSIDE

THIS PRINT AND ALL RIGHTS TO THE DESIGN ARE RESERVED BY THE DESIGNER. ANY REPRODUCTION OF THIS PRINT WITHOUT THE WRITTEN PERMISSION OF VT SVC, WASHINGTON, N.C. AND IS LOANED TO THE RECIPIENT SUBJECT TO RETURN UPON DEMAND. THIS PRINT IS NOT TO BE COPIED OR SUBMITTED TO OUTSIDE PARTIES FOR USE OR EXAMINATION.

NOTE: ESTIMATED DIMENSIONS. MEASUREMENTS DEPEND ON CHASSIS, TIRES, SPRINGS, AND LOADING.

 VT SVC © 2009 VT SVC A company of VT Systems		 Hackney EMERGENCY VEHICLES DIVISION WASHINGTON, NC 27889-0880	
PROJECT NO:	KMB	DATE:	11/10/09
SHEET:	1	OF:	4
MODEL:	09F20041	SCALE:	75
LAKE CARMEL		DRAWING NO: D-09C-210	
FIRE DEPARTMENT		REV: A	

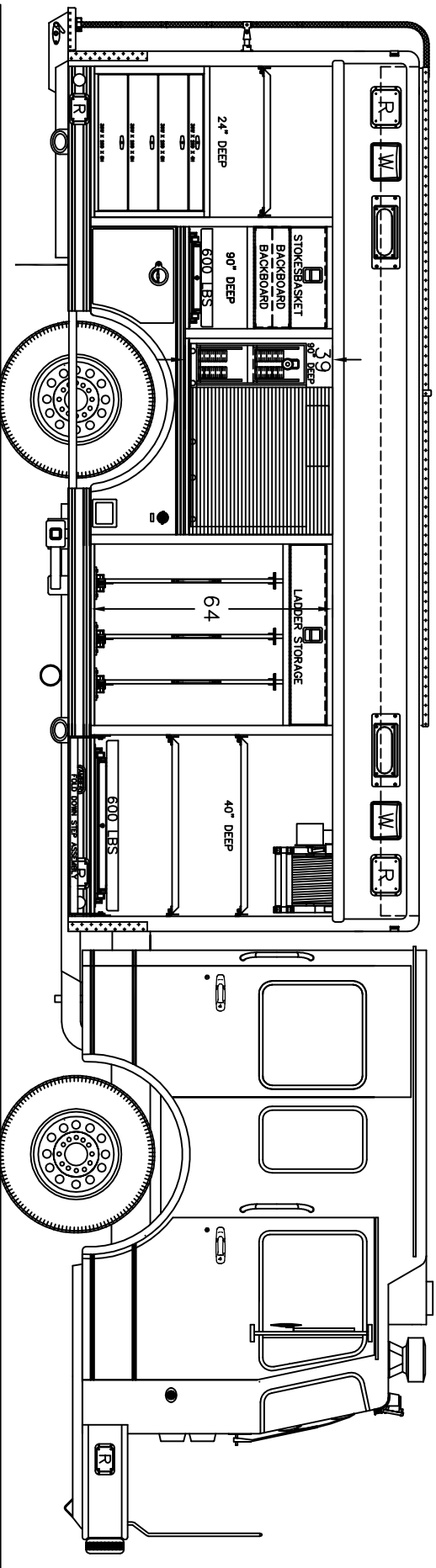

CURBSIDE

THIS PRINT AND ALL RIGHTS TO THE DESIGN AND INVENTION HEREIN ARE THE PROPERTY OF VT SVC, WASHINGTON, N.C. AND IS LOANED TO THE RECIPIENT SUBJECT TO RETURN UPON DEMAND AND MUST NOT BE COPIED OR SUBMITTED TO OUTSIDE PARTIES FOR USE OR EXAMINATION.

NOTE: ESTIMATED DIMENSIONS. MEASUREMENTS DEPEND ON CHASSIS, TIRES, SPRINGS, AND LOADING.



VT SVC © 2009 VT SVC
A company of VT Systems



EMERGENCY VEHICLES DIVISION
WASHINGTON, NC 27889-0880

PROJ. NO.	11/10/09	CUSTOMER DESIGN #06	LAKE CARMEL FIRE DEPARTMENT
DATE	11/10/09		
MODEL	KMB	SCALE	75
SHEET	2 OF 4	DRAWING NO.	D-09C-211
		REV.	A

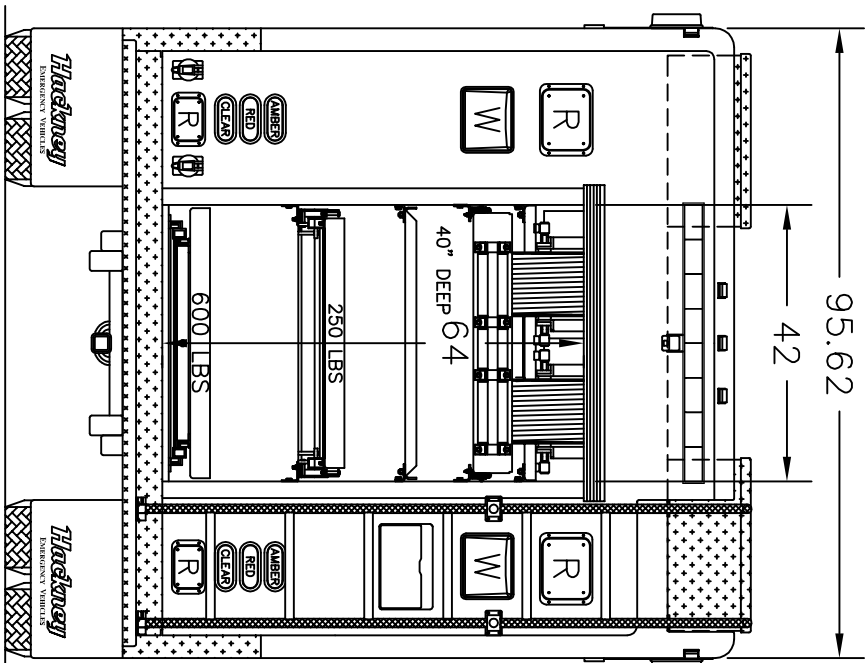

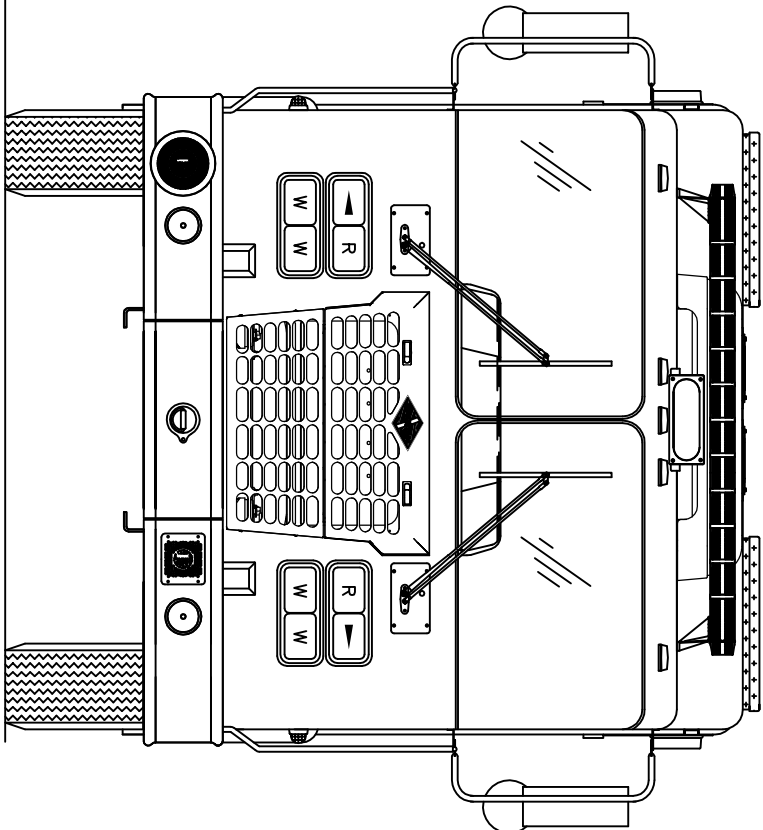

REAR VIEW



FRONT VIEW

THIS PRINT AND ALL RIGHTS TO THE DESIGN ARE RESERVED BY THE DESIGNER. THE DESIGN IS THE PROPERTY OF VT SVC, WASHINGTON, N.C. AND IS LOANED TO THE RECIPIENT SUBJECT TO RETURN UPON DEMAND. NO PARTS OF THIS DRAWING ARE TO BE REPRODUCED OR SUBMITTED TO OUTSIDE PARTIES FOR USE OR EXAMINATION.

NOTE: ESTIMATED DIMENSIONS. MEASUREMENTS DEPEND ON CHASSIS, TIRES, SPRINGS, AND LOADING.

 VT SVC © 2009 VT SVC A company of VT Systems		 Hackney EMERGENCY VEHICLES DIVISION WASHINGTON, NC 27889-0880	
DRAWN BY: KMB DATE: 11/10/09 SCALE: 1:10	CUSTOMER: LAKE CARMEL FIRE DEPARTMENT	SHEET: 3 of 4 MODEL: 09F20041	DRAWING NO: D-09C-212 REV: A

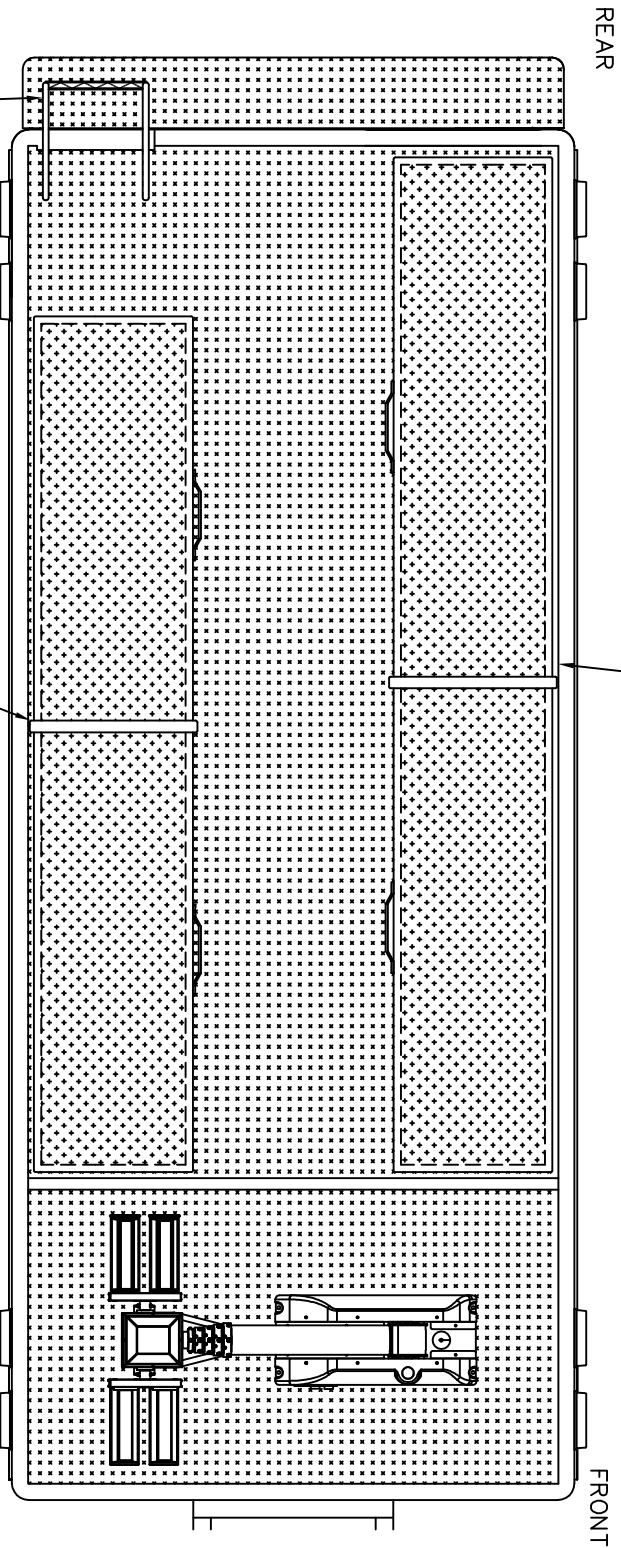

THIS PRINT AND ALL RIGHTS TO THE DESIGN ARE RESERVED BY THE DESIGNER. THE DESIGN IS THE PROPERTY OF VT SVC, WASHINGTON, N.C. AND IS LOANED TO THE RECIPIENT SUBJECT TO RETURN UPON DEMAND. IT IS NOT TO BE COPIED OR SUBMITTED TO OUTSIDE PARTIES FOR USE OR EXAMINATION.

NOTE: ESTIMATED DIMENSIONS. MEASUREMENTS DEPEND ON CHASSIS, TIRES, SPRINGS, AND LOADING.



VT SVC © 2009 VT SVC
A company of VT Systems



EMERGENCY VEHICLES DIVISION
WASHINGTON, NC 27889-0880

PROJ. NO.	DATE	CUSTOMER/DESIGN #/PK.	SCALE	DRAWING NO.	REV.
KMB	11/10/09		160	D-09C-213	A
SHEET	4 OF 4	LAKE CARMEL FIRE DEPARTMENT			
MODEL	09F2004 1				